

## REFERENCES

- Noorden, A.C., *Susswaren Tech. und Wirtschaft* 26:318 (1982).
- Rossell, J.B., *Food Flavourings Ingredients Processing and Packaging*, 5:28 (1983).
- Minifie, B.W., *Chocolate Cocoa and Confectionery*, J & A Churchill, London, 1970, p. 263.
- Patterson, H.B.W., *Hydrogenation of Fats and Oils*, Applied Science, (London and New York), 1983, pp. 144, 171.
- Thomas, A.E., and F.R. Paulicka, *Chem. and Ind. (London)*, 774 (1976).
- Eckey, E.W., U.S. Patent 2378 007 (1942).
- Murphy, J.F., U.S. Patent 2418 898 (1941).
- Brown, C.F., and C.M. Gooding, U.S. Patent 3512 994 (1966).
- Edelfettwerke G.m.b.H., British Patent 785,993 (1954).
- Baenitz, W., U.S. Patent 2371434 (1958, Germany).
- Seiden, P., U.S. Patent 3 595 673 (1968).
- Chapman, G.M., E.E. Akehurst, and W.B. Wright, *JAOCS* 48:824 (1971).
- Skau, E.V., W.N. Dopp, E.G. Burleigh, and L.F. Banowetz, *JAOCS* 27:556 (1950).
- Aarhus, Danish Patent 328/64 (1964).
- Rossell, J.B., *JAOCS* 52:505 (1975).
- Heraldson, G., Paper presented at Lipidforum Symposium, Gothenburg, Sweden, October 1975.
- Haraldsson, Paper presented at Kuala Lumpur Symposium, April 1978.
- Haraldsson, G., *La Rivista Italiana delle Sostanze Grasse* 54:325 (1979).
- Stein, W., *JAOCS* 45:471 (1968).
- Alpha Laval (Private Communication).
- Rek, J.H.M., and A.C.M. Appel, *JAOCS* 56:861 (1979).
- Aarhus Information Sheet on Cebes 30 - 01.
- Rossell, J.B., *Advances in Lipid Research*, edited by R. Paoletti and D. Kritchevsky, 5:353 (1967).
- Rossell, J.B., *Measurement of Rancidity*, edited by J. Allen and R.J. Hamilton, Applied Science, London, 1983, pp. 21-45.
- Bracco, U., *Lipids*, Vol. 2, Technology, edited by R. Paoletti, Raven Press, New York, 1976, p. 401.
- Berger, K.G., *Leatherhead Food RA Symposium Proceedings No. 19*, January 1984, p. 89.
- Ainger, G.E., and B.L. Caverly, British Patent 1382573 (1972).
- Cottier, D., and J.B. Rossell, British Patent 1495 254 (1973).

## Hydrogenation of Palm and Lauric Oils

B.G.M. GROTHUES, Walter Rau, Neusser öl und Fett AG, Postfach 183, 4040 Neuss 1, West Germany

### ABSTRACT

The technology and equipment for hydrogenating fats and oils is described. Advantages and disadvantages of various batch and continuous processes are discussed. Continuous hydrogenation is suggested for plants that process essentially only one type of oil. When several different feedstocks are to be processed in the same equipment, batch autoclaves may be advantageous.

Hydrogenated palm kernel and coconut oils or fractions have many uses in food products, especially in products where specific melting points and good oxidative stabilities are important. Trends in hydrogenation indicate that more and more energy-saving and automation devices will be used to reduce energy and labor costs and to make more uniform products, especially in batch processes.

### INTRODUCTION

Among the modification processes of edible oils and fats catalytic hydrogenation is by far the most important. By Wilhelm Normann's invention in 1911 a sufficient world supply of hard and spreadable fats was secured. In 1980-81 liquid oils including fish oils represented almost 57% of the total annual production of oils and fats worldwide (Table 1).

The main reasons for hydrogenating oils are to solidify liquid and semiliquid oils and to improve the oxidative stability. Solidification, of course, includes modification or amelioration of such rheological properties as plasticity, spreadability and hardness of fats which are already solid at ambient temperatures.

Palm and lauric oils belong to this type of fats. Large quantities of these fats are used for human consumption as such without modification. Also, large amounts are subjected to fractionation, hydrogenation and interesterification. Hydrogenation in this case is only one process among others. Nevertheless, it is indispensable in the concert of procedures at hand for preparation of specialty fats.

Dealing with the hydrogenation of palm and lauric oils today includes the hydrogenation of their derivatives obtained by fractionation processes. The oleins and stearins of palm and palm kernel oil are of extraordinary importance. Recently coconut oil fractions, too, acquired increasing interest.

Prior to a short description of the various applications of all the numerous fats available the modern technology of fat hydrogenation shall be discussed.

TABLE I

Total World Production of Edible Oils and Fats in 1980-81<sup>a</sup>

| Oil/fat                      | Production  |       |
|------------------------------|-------------|-------|
|                              | × 1000 M.T. | (%)   |
| Liquid oils:                 |             |       |
| Soybean oil                  | 13.120      | 23.3  |
| Sunflowerseed oil            | 4.744       | 8.4   |
| Rapeseed oil                 | 3.940       | 7.0   |
| Cotton oil                   | 3.175       | 5.6   |
| Peanut oil                   | 2.527       | 4.5   |
| Olive oil                    | 1.965       | 3.5   |
| Fish oils                    | 1.179       | 2.1   |
| Linseed oil                  | .704        | 1.2   |
| Sesame oil                   | .625        | 1.1   |
| Total liquid oils            | 31.979      | 56.6  |
| Solid fats:                  |             |       |
| Tallow                       | 6.268       | 11.1  |
| Butterfat                    | 5.651       | 10.0  |
| Lard                         | 4.833       | 8.5   |
| Palm oil                     | 4.505       | 8.0   |
| Coconut oil                  | 2.733       | 4.8   |
| Palm kernel oil              | .602        | 1.1   |
| Total solid fats             | 24.592      | 43.5  |
| Total oil and fat production | 56.575      | 100.0 |

<sup>a</sup>Source: *Oil World*.

### MODERN TECHNOLOGY OF FAT HYDROGENATION

Hydrogenation of oils and fats is a very complex process, controlled mainly by: starting and hydrogenation temperatures, hydrogen pressure, type and amount and catalyst, design of the hydrogenation reactor and type and quality of the oil. From one input raw material a great number of finished products with widely differing chemical and/or physical properties can be obtained (1-8).

Total hydrogenation with complete saturation of all double bonds ( $IV < 1$ ) is normally of limited interest for edible fats. Exceptions are the lauric fats, which are mainly treated in this way. Other totally hydrogenated fats with extremely high melting points are transferred into edible

## PALM AND LAURIC OIL HYDROGENATION

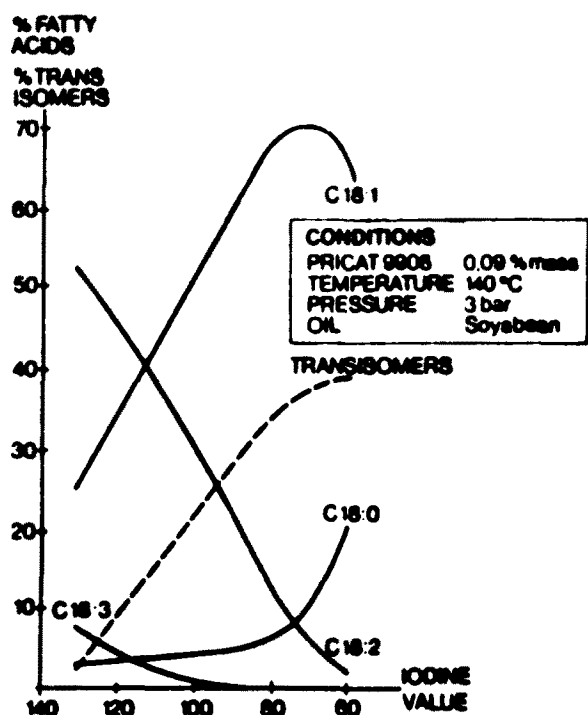

FIG. 1.  $S_1$ -selective hydrogenation of soybean oil (Courtesy of Unichema).

fats by interesterification with liquid oils and/or lauric fats (9,10).

Normally the production of edible fats by hydrogenation means partial hydrogenation. The "selectivity" of this process is of crucial importance. Two main types of selectivity are:

- $S_1$ -selectivity: Expression for the preference of dienoic acid- to monoenoic acid-hydrogenation. Figure 1 shows the alterations of the  $C_{18}$ -fatty acids of soybean oil during a  $S_1$ -selective hydrogenation.

- $S_i$ -selectivity: Expression for the extent of *cis/trans*-isomerization of double bonds during the hydrogenation (isomerized double bonds/hydrogenated double bonds).

For more information concerning the hydrogenation reaction see references (11-16).

Palm kernel oil and its stearin fractions, and particularly coconut oil, when hydrogenated, are almost entirely saturated to an  $IV < 1$ . This task is very simple; only a catalyst of high activity is required.

Palm oil and palm olein, as well as to some extent palm kernel oil and palm kernel oleins, are preferably subjected to partial hydrogenation in order to eliminate the linoleic acid ( $S_1$ -selectivity) and to improve the oxidation stability. Simultaneously, the melting behavior will be ameliorated.

Palm oil and palm oleins are also hydrogenated under *trans*-promoting conditions ( $S_i$ -selectivity), to produce fats with a high *trans*-fatty acid content and steep dilatation curves. Figure 2 compares the dilatation-curves of  $S_1$ -selectively and  $S_i$ -selectively hydrogenated palm oil.

Discussions on potential health risks of *trans*-isomer fatty acids have revived recently (17-20). Without going into details the following results of a great number of scientific investigations should be mentioned:

- Fats with *trans*-fatty acid-content cannot necessarily be called "unnatural fats." Various naturally occurring fats contain up to 17% of *trans*-fatty acids.

- Fats are a main source of energy. The function of *trans*-fatty acids in biological combustion is comparable with that of saturated fatty acids.

- *Trans*-fatty acids may also become constituent parts of phospholipids in cells and particularly in bio-membranes. *Trans*-monoenoic acids can be seen in their biological properties between *cis*-monoenoic and saturated fatty acids. Concerning the dienoic acids, the *cis-trans*- and the *trans-cis*-isomers can be compared with ordinary monoenoic fatty acids, where the *trans-trans*-isomers seem to block the introduction of polyunsaturated fatty acids into the  $\beta$ -position and show a distinct essential fatty acid antagonism (EFA). As *trans-trans*-linoleic acids have been found in trace amounts only, even in partially hydrogenated soybean oil, they are without importance considering hydrogenated palm and lauric oils.

- As *trans*-containing dienoic acids have no essential quality, a sufficient supply of essential fatty acids in the diet ( $\geq 5\%$ ) should always be provided.

#### TECHNOLOGY AND EQUIPMENT FOR FAT HYDROGENATION

Oils and fats for catalytic hydrogenation should be refined, that is degummed, neutralized and bleached. Degumming often is necessary in order to remove mucilaginous phosphatides, proteins, vegetable gums, etc., which may mechanically block substantial surface area of the catalyst and

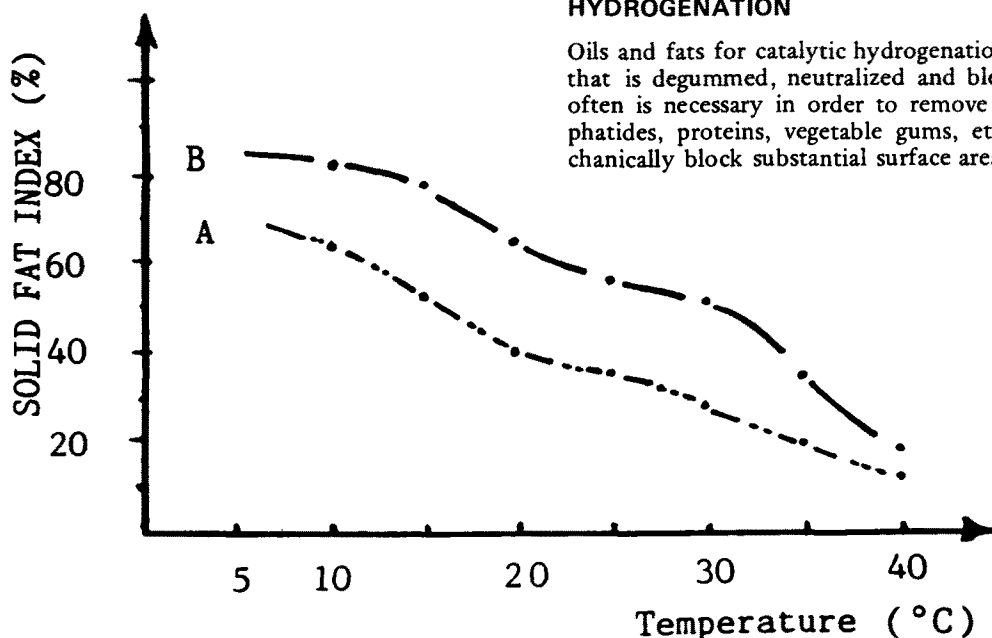

FIG. 2. Dilatation curves of  $S_1$ - and  $S_i$ -selectively hydrogenated palm oil (Courtesy of Unichema).

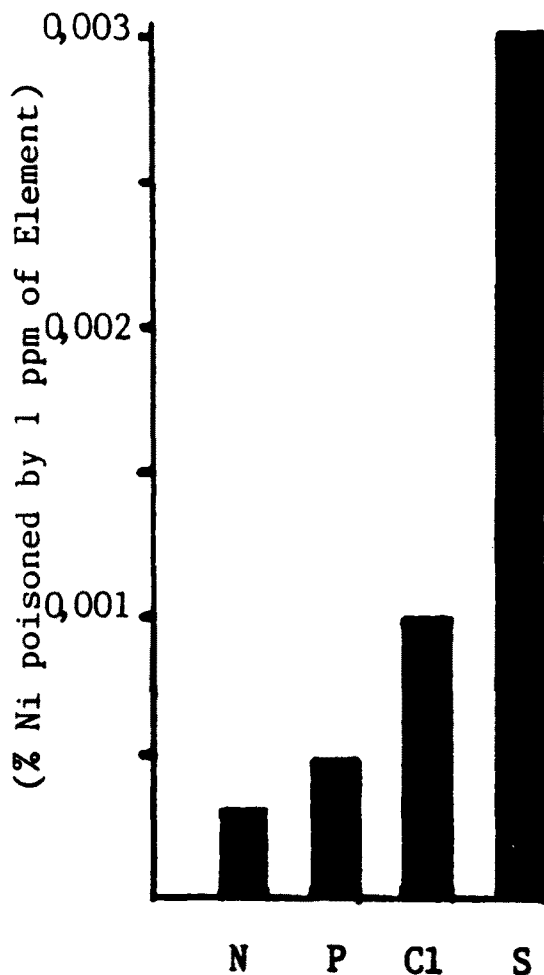

FIG. 3. Relative poisoning effect of some elements on Ni-hydrogenation catalyst (22).

TABLE II

Display of the Main Types of Fat Hydrogenation Equipment

- |  |  |
|--|--|
| A. Batch autoclaves                        |  |
| 1. Agitator-equipped reactors              |  |
| (a) Propeller and guiding pipe             |  |
| (b) High-speed flat-blade stirrer          |  |
| (c) Low-speed multistage stirrer           |  |
| 2. Loop reactor                            |  |
| B. Continuous-type hydrogenation equipment |  |
| 1. Lurgi process                           |  |
| 2. Buss cascade processes                  |  |
| 3. King Dravo process                      |  |

generate dark and resistant colors of the fat. Neutralization is advised in order to prevent the formation of nickel soaps and the pickup of prooxidative iron from the autoclave construction material. Moreover, a lot of more or less effective catalyst-poisons (21) are removed. Bleaching sometimes may be omitted. In general however, it will not pay to omit it as the loss in catalyst activity with reduced recycling ability and the potential reduction of  $S_1$ -selectivity as well as an increased demand of bleaching clay for post-refining will at least match the real advantages of saving one refining step. Figure 3 shows the relative poisoning effect of several elements on Ni-catalyst (22).

The proper hydrogenation process comprises

- heating of the oil/fat to reaction temperature
- hydrogenation in the presence of Ni-catalyst and hydrogen with cooling if the heat of reaction is not needed

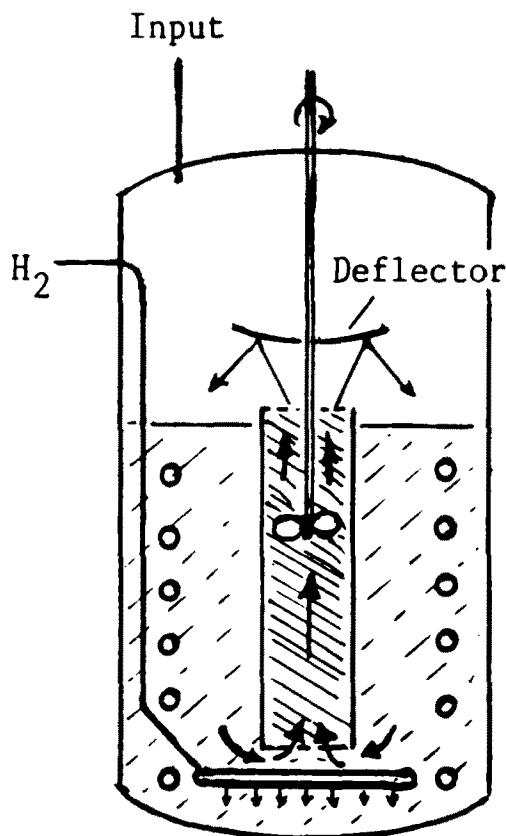

FIG. 4. Batch autoclave with propeller-stirrer and guiding pipe.

for further increase of temperature

- cooling of the reaction mixture to filtration temperature and removal of catalyst by filtration

Hydrogenation can be done as well by batch as by continuous processing. Table II shows the main types of batch and continuous hydrogenation equipment.

Though in oil and fat processing generally the continuous process is becoming wider used, hydrogenation is still mainly performed by batch processes. The decisive advantage of batch hydrogenation is its great flexibility. Hydrogenation conditions can be adapted to the specific raw material and to the desired endproducts, and the change from one product to another one is easy.

#### BATCH AUTOCLAVES

Concerning the design of batch autoclaves we differentiate between agitator-equipped and loop reactors. Generally the autoclave has to fulfill the following technological functions:

- The oil/fat should be heated to reaction temperature as fast as possible, without local superheating.
- The hydrogenation catalyst should be suspended in the oil/fat as homogeneously as possible.
- Gaseous hydrogen has to be dispersed in the oil/catalyst suspension.

Most hydrogenation reactors are designed as tall vessels, in order to provide a long path for the ascending hydrogen. With this precondition the crucial feature of the autoclaves is the means and extent by which the above tasks are achieved.

Figure 4 shows an autoclave, equipped with a fast-running propeller-agitator, adjusted in the upper part of a guiding pipe. Hydrogen is introduced at the reactor bottom by a ring-pipe, perforated at the lower side. The agitator pump-like forces the mixture of oil, catalyst and hydrogen through the vertical pipe against a deflecting disk, fixed at the axis

of the stirrer. So the mix splashes back to the surface of the reactor filling, absorbing unreacted hydrogen from the headspace for further hydrogenation. Advantages of this type of reactor are the fairly low investment costs and its ability to react the injected hydrogen completely without an external gas circuit (dead-end reactor). Disadvantages are:

- The vessel must be filled to an almost constant level to ensure proper function,

- The heat transfer for heating as well as for cooling is inferior to other designs, and

- The high-speed stirrer may cause some mechanical damage of the catalyst's structure and filtration problems by ultrafine degradation particles.

Another type of reactor (Fig. 5) is equipped with a high-speed radial flow flat-blade agitator. This construction provides an excellent hydrogen-dispersion, whereas the catalyst-suspension is poor. The energy consumption is high and the heat exchange in these autoclaves is reasonable. In spite of the good hydrogen dispersion unreacted gas will collect in the headspace without substantial reabsorption by the reaction mixture. So the headspace- $H_2$  must be recycled by a special recycling and gas-cleaning system. Formerly this recycling technology was very common, and today still about 50% of the existing plants may be of that type. New plants, however, are equipped almost entirely by dead-end autoclaves. This alternative type of reactor has two main advantages: it shows an excellent  $S_1$ -selectivity and is insensitive to various liquid levels. Mechanical stress on the catalyst is even higher than by the propeller-agitator.

A third widespread type of batch-hydrogenator is fitted with a slowly rotating multistage-agitator of varying design. Contrary to the flat-blade agitator already mentioned, which induces mere radial flow to the mixture, this agitator induces radial and axial flow. Extraordinary dispersing and suspending action combined with high heat exchange rates can be obtained by using so-called MIG-agitators (Multistage Impulse Countercurrent Mixer) (23-24) or the further advanced INTER-MIG-stirrer (Interference Flow stirrer). Figure 6 shows such an autoclave, equipped with a 5-stage-MIG-stirrer and a variable gear. The top stage of the stirrer is specially designed normally for the incorporation of

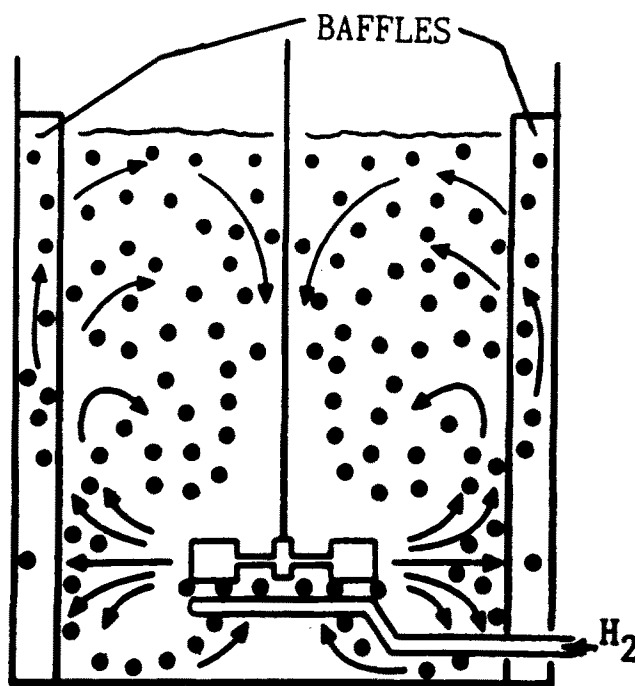

FIG. 5. Autoclave, equipped with a radial flow-flat-blade agitator: dispersion of hydrogen bubbles (1).

hydrogen from the head space. The special structures of the MIG- and Inter-MIG-stirrer can be seen from Figures 6(a) and 6(b). Reactors of this type provide good  $S_1$ -selectivity and can be used as dead-end autoclaves. The mechanical stress on the suspended catalyst is lower than with high-speed agitators.

The most recent type of batch hydrogenator is the loop-reactor (26,27) operating entirely differently compared to the above described autoclaves (Fig. 7). The reaction vessel contains no installations except the injection-nozzle protruding into the top part. Heating and cooling are accomplished by a heat exchanger installed in the circulation-loop. The reaction mixture is pumped from the reactor through the heat exchanger and a venturi jet back to the autoclave by a high-capacity centrifugal pump. The venturi jet provides introduction of the hydrogen and, in connection with the circulating pump, the intense mixing and dispersing effect. The function of the pressure vessel is mainly that of a storage tank where the induced reaction of  $H_2$  with the oil takes place and expires unless by another circulation additional hydrogen is injected. The unreacted  $H_2$ , collected

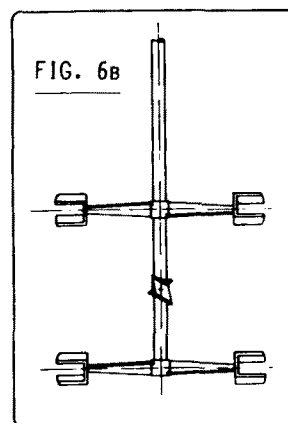
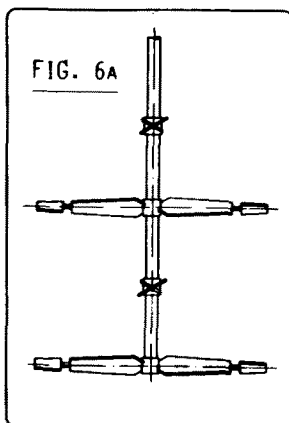
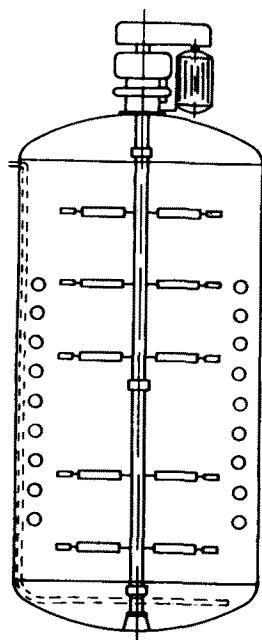

FIG. 6. Autoclave, equipped with five-stage MIG-stirrer and variable gear (EKATO-RÜHR- UND MISCHTECHNIK). 6(a) and 6(b): Detailed drawings of MIG and inter-MIG-stirrers (EKATO-RÜHR- UND MISCHTECHNIK).

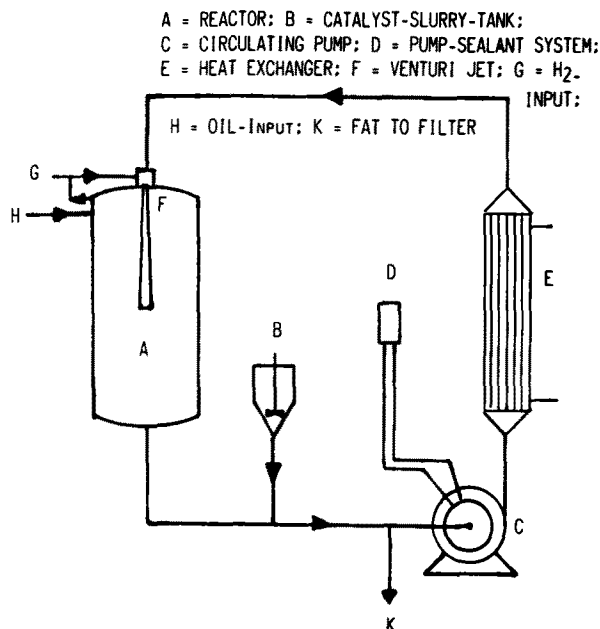

FIG. 7. Flowsheet of a BUSS loop reactor.

in the headspace, is sucked into the venturi jet, to be incorporated again into the reaction mixture in a kind of internal recycling. This type of reactor shows a good  $S_1$ -selectivity. Heating and cooling are performed with high efficiency and the reaction temperature can be controlled very sensitively. Some mechanical stress on the catalyst by the circulation pump must be accepted.

#### CONTINUOUS-TYPE HYDROGENATION EQUIPMENT

Almost from the beginnings of fat hydrogenation, efforts have been made to develop a continuous hydrogenation process (28,29). The commercial success however was rather poor. Today three different processes are of some limited importance. They all use a suspended nickel-catalyst. All attempts to use fixed-bed catalysts failed.

The main advantages of the continuous system are:

- energy-saving by use of countercurrent heat exchange,
- constant energy and cooling water consumption,

- constant input of raw material, catalyst and hydrogen as well as constant discharge of hardened fat,
- constant quality of finished product by continuous process control, and
- minimal manpower, as the process is suitable for high-grade automation.

The two crucial disadvantages are:

- the lack of flexibility in case of frequent product alterations, and
- the reduced  $S_1$ -selectivity (to some extent) in case of partial hydrogenation.

The Lurgi Process of continuous hydrogenation is outlined in Figure 8. The raw material, mixed with the catalyst flows cocurrent with hydrogen through the tall reactor D 1. Unreacted hydrogen is recycled into the oil/catalyst stream. Most of the installed capacities are used for the hydrogenation of fatty acids.

The BUSS AG, Basel, has developed a continuous hydrogenation process basing on the loop reactor (30). According to Figure 9 interconnected loop reactors with a joint headspace are combined in a cascade in order to avoid substantial backflow and outage of product and to get a homogenous hydrogenation with reasonable selectivity. The more cascades, the steeper is the residence-time diagram. Instead of one compact processing unit BUSS also provides combinations of 2 to 4 batch-type loop reactors to a process cascade (Fig. 10).

Finally, the DRAVO (formerly BLAW-KNOX) -KING process of continuous hydrogenation has to be mentioned, reported to be in use in the USA with good success (31,8). Figure 11 demonstrated the principle of this process: The raw material/catalyst mixture is deaerated and dried under vacuum, heated by heat exchange and preheater to reaction temperature and fed into the reactor, consisting of a long pipe. During the passage the oil/catalyst suspension is supplied with proportionate amounts of hydrogen in different sections of the pipe. Under well-controlled conditions a defined endproduct can be obtained. The process is said to have a good  $S_1$ -selectivity.

This review of different types of hydrogenation equipment leads to a discussion of suitable and recommended types for hydrogenation of palm and lauric oils and their derivatives. Plants in the growing areas of oil and coconut palms can be expected to process large quantities of these oils. Moreover, at least coconut and palm kernel oils are

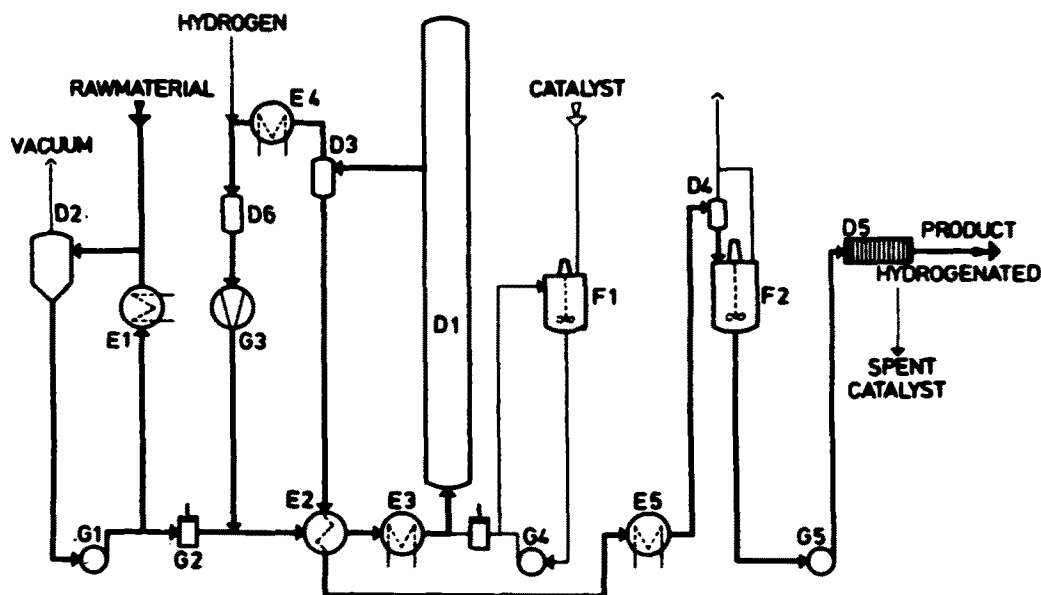

FIG. 8. Process diagram of LURGI process for continuous hydrogenation.

## PALM AND LAURIC OIL HYDROGENATION

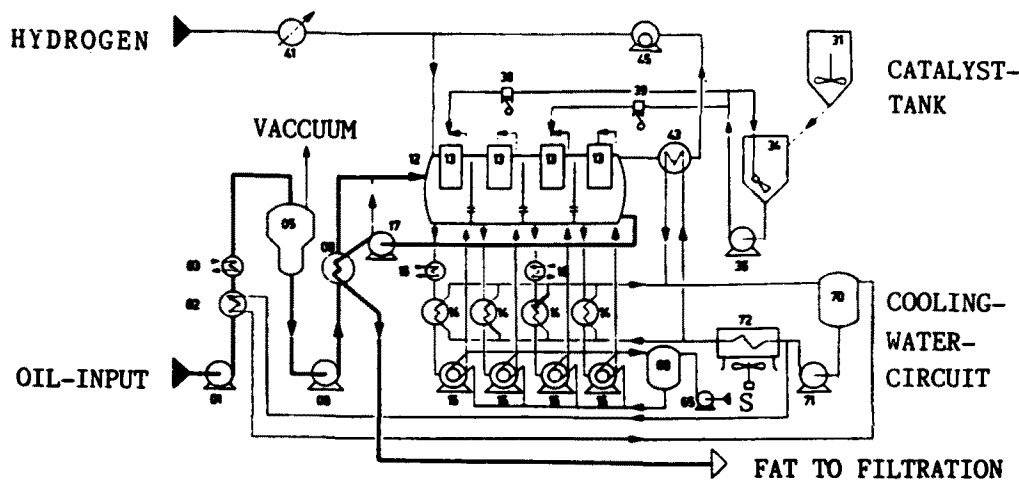

FIG. 9. Flow sheet of a continuous BUSS hydrogenation unit with four loops.

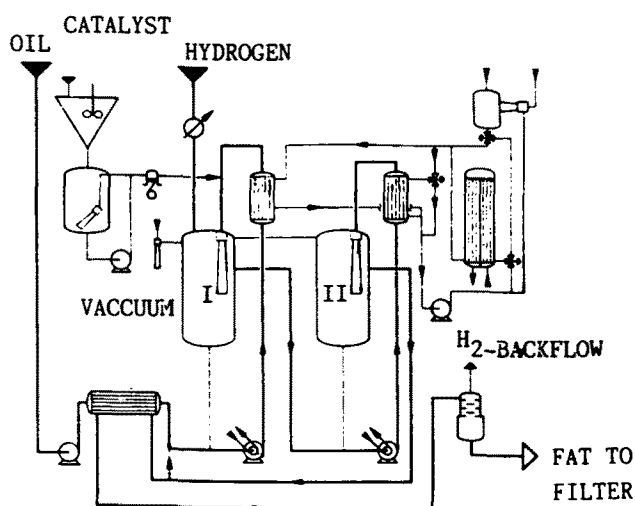

FIG. 10. Continuously working cascade of two loop reactors.

totally hydrogenated mainly. Therefore, a continuously running plant may be a good choice, particularly in case of continuously running equipment before and after hydrogenation.

Factories with a great variety of products, requiring partial and selective hydrogenation may preferably use batch autoclaves, the more so as the latest developments in energy-saving techniques make batch operation more attractive. So BUSS added two suitable vessels, one ahead of and the other after the reactor and two appropriate heat exchangers (Fig. 12).

The hydrogenated fat is discharged into a holding tank, C. The hot fat transfers its heat by a heat recovery unit, D, consisting of two heat exchangers with an intermediate vacuum dryer, to the input material of the next batch which is stored under vacuum in a second holding tank, A, on top of the reactor. From this tank it can be transferred to the reactor, B, the moment the latter has been emptied to C. As the feed is already on hydrogenation temperature, hardening can start without delay. The hydrogenated fat is drained to a third holding tank, E, the temperature reduced to filtration level (27). Besides the heat recovery and the increase of productive time, this system produces substantial amounts of low-pressure steam, when deducting the heat of reaction by controlled condensate injection (32). Similar systems of heat recovery, among others joining two batch autoclaves and heat exchangers to one processing unit, have been realized by P.A. Bolheimer Jr. (33), by De Smet (34) and by DIBA-WR-Technik (Fig. 13).

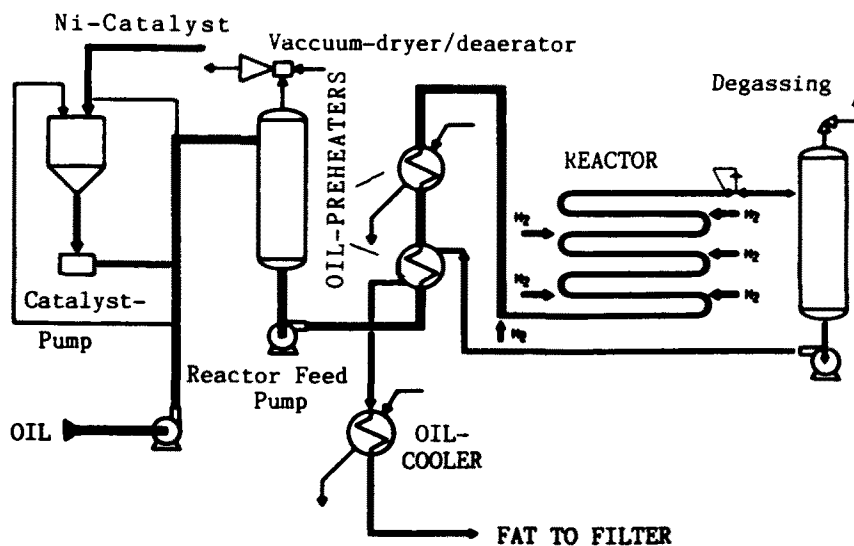

FIG. 11. Flowsheet of a continuous hydrogenation according to the KING/DRAVO process (8).

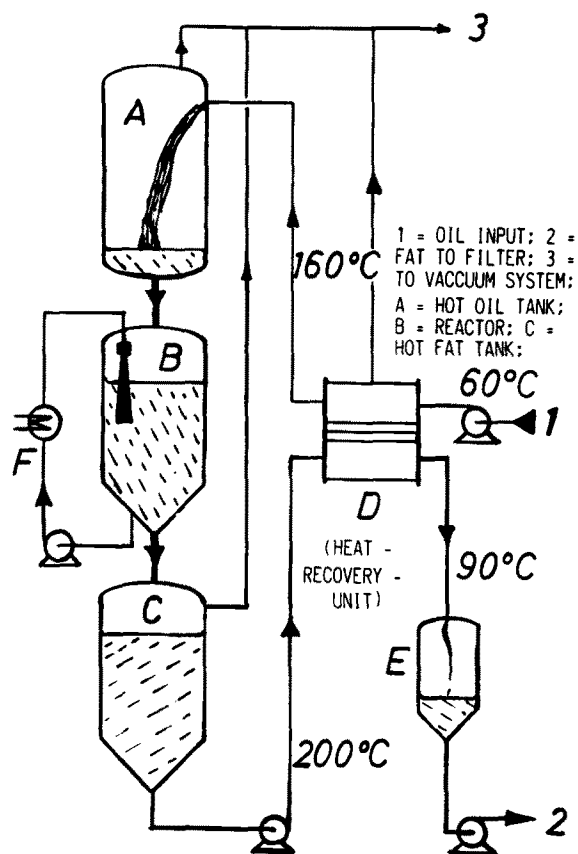

FIG. 12. BUSS heat-recovery system (32); 1 = oil form storage; 2 = fat to filter; 3 = to vacuum pump. A = hot oil tank; B = hydrogenator; C = hot fat tank; D = heat recovery unit, consisting of two heat exchangers with an intermediate vacuum dryer; E = fat filtration buffer tank; F = loop with pump, heat exchanger and venturi jet.

### AUXILIARIES

The main auxiliaries of the hydrogenation process are the hydrogen gas and the catalysts. For oils and fats hydrogenation mainly nickel catalysts are used. In case of extreme  $S_2$ -selectivity special copper catalysts have been developed (2,35). However, these are of limited importance.

Nickel catalysts are chiefly of the dry-reduced type, the active nickel supported by a selected carrier, mainly kiesel-

TABLE III

Nickel Catalyst Brands of Three Main Catalyst Suppliers

| Type of catalyst | Suppliers  |              |             |
|------------------|------------|--------------|-------------|
|                  | Harshaw    | Südchemie AG | Unichema    |
| $S_1$ -selective | Nysel DM 3 | KE-NF 20     | Pricat 9906 |
| Highly active    | Resan 22   | G - 50       | Pricat 9900 |
| $S_2$ -selective | Nysel SP 7 | G - 111      | Pricat 9908 |

<sup>a</sup>Nickel-subsulfide-catalyst ( $Ni_3S_2$ ) (36).

guhr with large internal surface. The catalyst support must be selected very carefully in order to provide special properties to the catalyst. Suitable pore dimensions and mechanical stability, that is, resistance against degradation by the impact of agitator blades or pump rotors, must be taken into account. Soft material may be crushed to micronized particles leading to filtration troubles. Poor filterability is the main reason that the formerly very common formate-catalyst, consisting of finely divided metallic nickel without support, has lost the competition with the supported catalysts, in spite of its excellent  $S_1$ -selectivity.

Catalyst suppliers normally offer three main types of catalysts with:

- high  $S_1$ -selectivity,
- high activity and mere good  $S_1$ -selectivity, and
- high  $S_2$ -selectivity.

Table III lists the catalysts of different suppliers. For safe delivery and handling catalysts are included in a protective fat, e.g., totally hydrogenated tallow or soybean oil. Lauric fat coatings are available on special request only. The flaked catalyst with 20 to 25% of nickel content is about to be replaced by a lozenge- or droplike product. The latter has a smaller surface-to-weight ratio, a better mechanical stability against abrasion and, moreover, superior flow properties.

For the removal of catalyst from the hydrogenated fat mainly regular chamber-filter presses—as automated as possible—equipped with preshrunk filtercloths and filterpapers, are used. Pressure filters with stainless steel filter leaves are also in use, particularly in plants where the catalyst is not reused. This filter type requires a precoating with

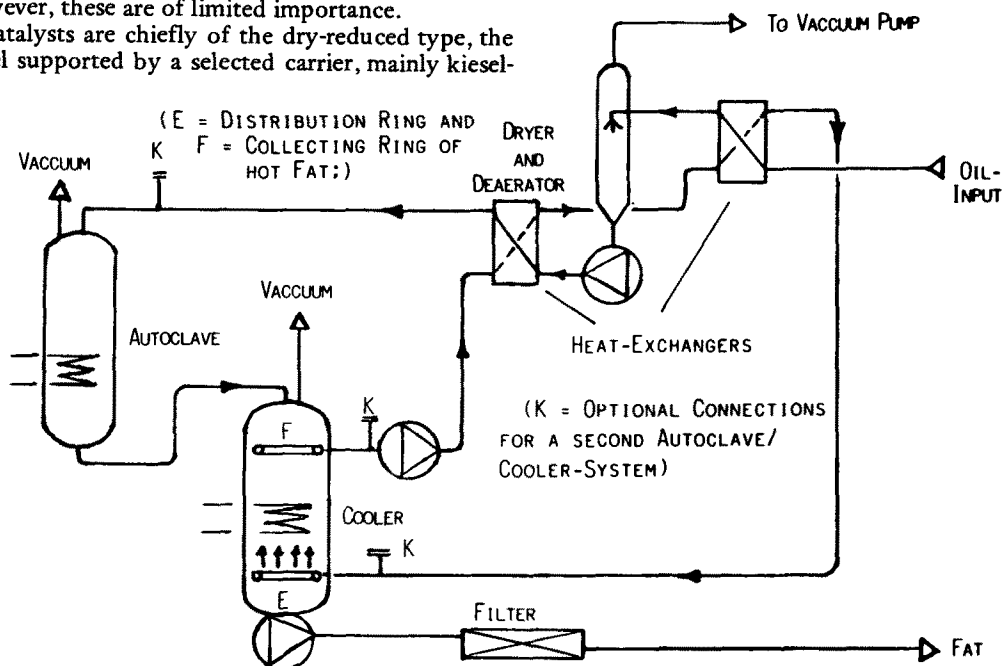

FIG. 13. Flowsheet of a heat recovery installation system (DIBA-WR-TECHNIK).

## PALM AND LAURIC OIL HYDROGENATION

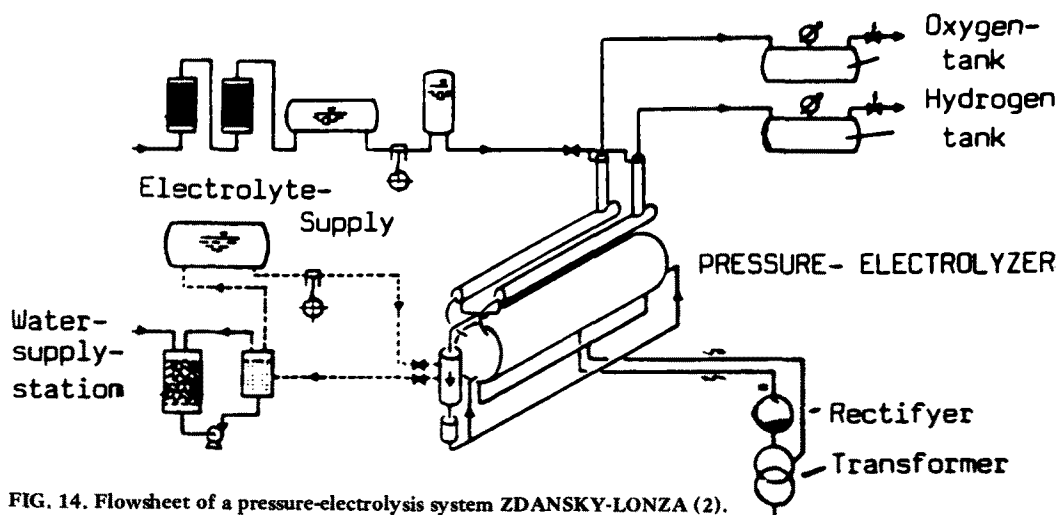

FIG. 14. Flowsheet of a pressure-electrolysis system ZDANSKY-LONZA (2).

filter aid, diluting the catalyst with inactive material. Spent catalyst may become too low in Ni content for economic recycling. Moreover the filtration of the final content of the filter vessel prior to the discharge of catalyst may cause problems when hydrogenating a variety of different hardened fats.

Hydrogen can be provided mainly by:

- purchase from the chemical and/or petrochemical industry,  $H_2$  being available as a byproduct of different inorganic or organic processes and delivery by batteries of high-pressure steel-cylinders.

- on-site production by electrolysis, preferably pressure-electrolysis (Fig. 14), if electric energy is available at low price (e.g., special price during period of low electricity demand, using an appropriate  $H_2$ -buffer tank). The oxygen byproduct may provide additional earnings.

- On-site production by converting propane/butane or natural gas by a modern gas-conversion plant, which is available today in highly automated design down to a capacity of  $200 \text{ Nm}^3/\text{h}$ .

- On-site production by splitting of methanol by means of the Lurgi-Proximol-process (38) ( $\text{CH}_3\text{OH} + \text{H}_2\text{O} \rightarrow \text{CO}_2 + 3 \text{H}_2$ ), if methanol is available at a competitive price.

The best alternative must be selected according to the actual situation at the respective plant. Designing a hydrogenation plant for palm and lauric oil means a fairly low hydrogen demand, compared to a plant for processing highly unsaturated oils like soybean oil or fish oil.

The theoretical hydrogen demand per metric ton of input material can easily be calculated from the reduction of the IV (iodine value):

$$\text{Nm}^3 \text{ H}_2/\text{t} = \frac{\text{IV}_e - \text{IV}_a}{1,14}$$

( $\text{IV}_e$  = IV of the endproduct and  $\text{IV}_a$  = IV of the input material).

## USES OF HYDROGENATED PALM AND LAURIC FATS

### Coconut Oil and Its Derivates

Coconut oil contains about 4-8% of oleic and 1-3% of linoleic acid (IV 8-11). The normal hydrogenation provides a fat with a melting point of ca. 32 C. The SFI curves of the original and hydrogenated fat are shown in Figure 15. The steep curve of the coconut oil, responsible for its agreeable cooling effect on the palate is flattened to some extent by the hardening, because small amounts of triglycerides formed are still solid at 35 C. In order to prevent the formation of these higher-melting components the hydrogenation is some-

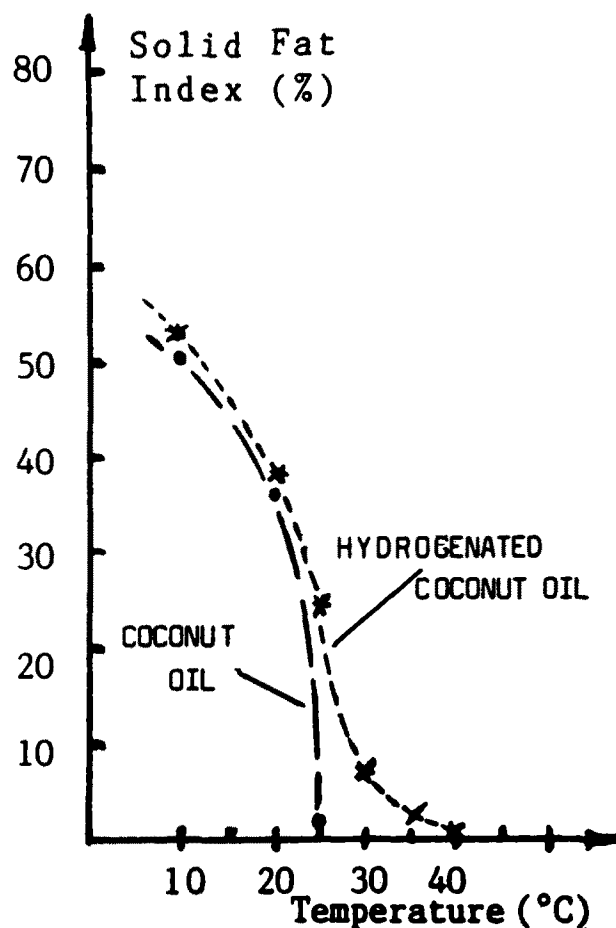

FIG. 15. Solid fat index curves of coconut oil and hydrogenated coconut fat.

times stopped at an approximate IV of 3-4 corresponding with a melting point of about 29 C. For this hydrogenation an active catalyst is suitable. The fully hydrogenated protective coating on the catalyst increases the content of high-melting triglycerides. So in special cases the use of hydrogenated coconut oil-suspended catalyst may be advised.

By solvent fractionation coconut stearin and olein can be produced. They also can be hydrogenated for special applications. Unhydrogenated coconut oil is widely used as a household fat for cooking, roasting and frying, packed as shortening in cartons or tins and as a compact fat in slabs.



The sometimes unfavorably low melting point in summer or in hot climates can be overcome by partial or total substitution by the hydrogenated fat.

Industrial applications comprise the use of unhydrogenated as well as hydrogenated products as margarine components, as cream fat for wafer fillings, filling of cookies, snacks, pralines and filled chocolates, as a coating fat for bakery products and particularly for ice cream. Last but not least they are the main fat basis of the so-called ice confectionary. Particularly in the field of sweets and confectionary the scope of variations, including the fractions, sometimes blended and/or interesterified with other lauric components, is almost unlimited.

#### Palm Kernel Oil and Its Fractions

Palm kernel oil contains 9-15% of oleic and 1-2% of linoleic acid (IV ca. 18). With its slightly higher melting point compared to that of coconut oil, it is principally used for the same applications, though with different focusing. The predominance of applications in the sweets and confectionary industry to the lesser use in the households has several reasons:

- The higher melting point grants more thermal stability.
- The higher unsaturation allows the production of various fats with even higher stability by partial or total hydrogenation and the manufacture of a variety of hard fats with differing properties.
- Dry as well as solvent fractionation provide palm kernel stearins and oleins with interesting properties, either as such or after hydrogenation, sometimes with subsequent interesterification.

Particularly these stearin fractions and their hydrogenated and/or interesterified derivatives, eventually blended with one another and/or other lauric fats, constitute the so-called lauric cocoa butter substitutes (38-42) (CBS-laurics), with a melting behavior very similar to and sometimes even better than cocoa butter.

Figure 16 shows the SFI curves of palm kernel oil products in comparison with those of cocoa butter. The hydrogenation of the palm kernel oil products causes no problems. An active catalyst without special selectivity is quite suitable.

#### Palm Oil and Its Fractions

Huge amounts of palm oil and its fractions are used without hydrogenation in households as cooking, roasting, frying and baking fat or oil. For industrial purposes they are used as frying fats or oils, as shortenings for such applications as fat creams for fillings of wafers or cookies, and as components in margarine blends.

Intesterified mixtures of palm oil or its derivatives with lauric fats are of particular interest in this last-mentioned industrial sector. Natural palm oil contains 4-8% of high-melting trisaturated triglycerides, and its melting point is about 37-40 C. Hydrogenation for an improvement of the melting behavior must thus be performed in a very  $S_1$ -selective mode to avoid the formation of substantial amounts of stearic acid. The very character of the palm oil remains unchanged when hydrogenated at lower temperatures (<170 C). The oxidative stability is ameliorated by reduction of the linoleic acid content.

Using hydrogenation temperatures above 180 C as well as applying partially poisoned catalyst or even commercial sulfur-poisoned catalyst, hardened fats with high *trans*-rates and steep dilatation curves are obtained (Fig. 2). Such fats are very useful for margarine blends, for bakery shortenings and for all-hydrogenated vanaspati (vegetable ghee) in India. Completely hydrogenated palm oil (m.p. ca 59 C) is used as high-melting component in bakery shortenings (flakes) and as a crystallization promoter in certain confectionary fats.

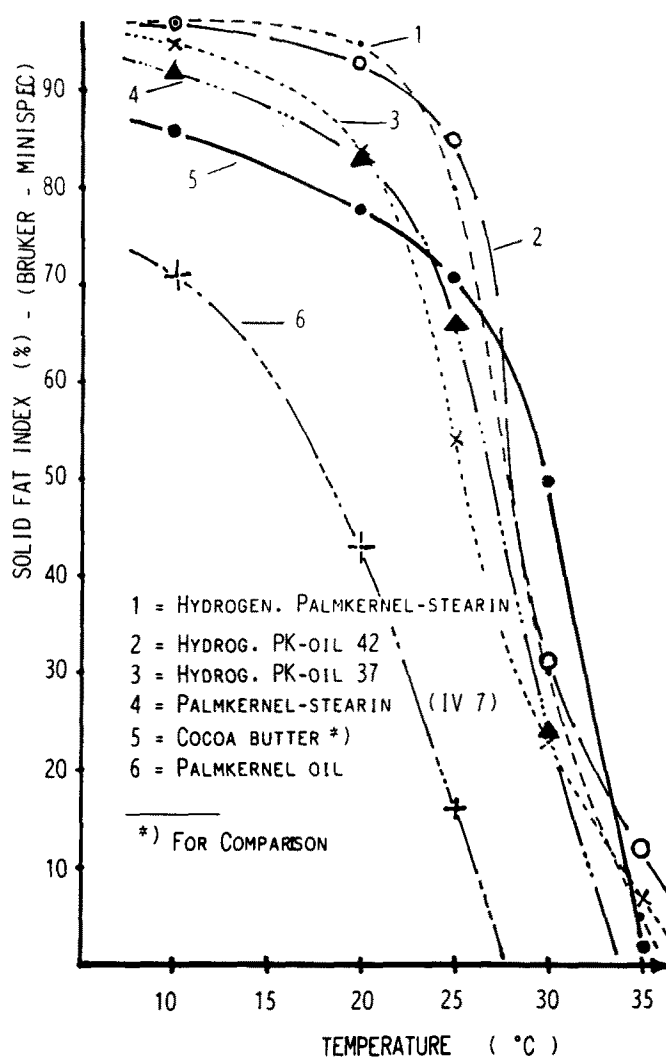

FIG. 16. Solid fat index curves of some palm kernel fats.

Percentages of 0.5-3 are normally used for this purpose.

Palm stearins contain even higher amounts of trisaturated glycerides. Therefore, they are used either as such in competition with partially hydrogenated palm oils or after total hydrogenation as interesterification component together with vegetable oils or lauric fats for the production of margarine or shortening components with high palmitic acid content. Such fats are of particular interest for bakery applications because they crystallize preferably in the  $\beta'$  form and have an excellent gas-binding ability.

Palm olein, like palm stearin, is a generic term, comprising a great variety of similar fractions, related to the fractionation method used. Oleins are more or less free of trisaturated glycerides. They are therefore of special interest, either for  $S_1$ -selective hydrogenations in order to prepare shortening-type fats with improved oxidative stability, or for a *trans*-promoting hydrogenation to manufacture valuable margarine components or fats for sweets and confectionary, either as such or after a subsequent fractionation as non-lauric cocoa butter substitutes (CBS-nonlaurics).

#### FUTURE DEVELOPMENTS IN HYDROGENATION TECHNOLOGY

The tremendous rise in energy costs after the oil shocks of 1974 and 1979 led to enormous savings in energy by general improvements of processing conditions. Many process alterations that affect oil and fat hydrogenation have been

## PALM AND LAURIC OIL HYDROGENATION

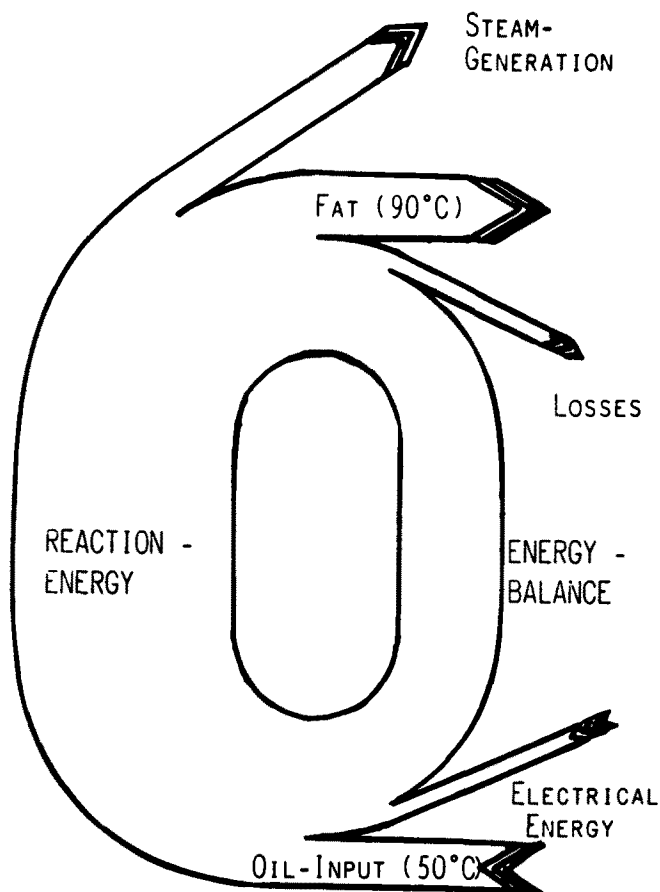

FIG. 17. Energy flow diagram of the BUSS heat-recovery system (Fig. 12).

realized. These changes involve heat recovery either by using continuous processes or by skillful combination of batch reactors with additional equipment.

The reaction enthalpy of the hydrogenation reaction can be used to produce live steam for other purposes. A complete energy-flow diagram of a BUSS hydrogenation plant is shown in Figure 17. Further progress in this field will be made, e.g., by the integration of the hydrogenation unit into the continuous or semicontinuous flow of pre- and postrefining. In particular palm oil and laurics can be refined by physical pretreatment and subsequent distillative deacidification and deodorization.

Some factories with a larger hydrogenation facility may be in a dilemma. Physical refining, particularly of fresh raw materials, includes obvious advantages and is widely used for palm and lauric oil refining. To supply the hydrogenation with the necessary input material requires either a classical alkali refining plant or an adequate distillation and deodorization capacity. Arguments in favor of the second alternative may be:

- Steam-deacidified and -deodorized fat can be transferred to the hydrogenator directly, only after a moderate cooling by heat exchanger from the deodorization temperature to the starting temperature of the hydrogenation.

- Use of fully refined and degassed oil as hydrogenation input material will reduce catalyst costs, as poisoning will be minimized. A high catalyst activity and, if required, selectivity can be expected.

- Efficiency of a given reactor will be optimized, as minimum hydrogenation times will be attainable.

- Finished products will be of high quality and post-refining will require only minor efforts.

The development of microelectronics is increasingly revolutionizing the world. The comparable unreliability of

manpower in the case of continuously repeated sequences of processing or controlling processes in connection with constantly increasing labor costs in the calculation sheets will inevitably lead to increased use of electronic intelligence in the hydrogenation process too. In developed countries with a high standard of living there is a general tendency for the manufacture of more and more sophisticated food products, fabricated on industrial scale in large quantities by special machines. Such production processes require highly standardized ingredients, tolerating only small deviations from the standard specifications. The production of these ingredients requires automated processes.

The necessary preconditions—sensors, providing rapidly, continuously, exactly and reliably the process parameters of the hydrogenation (temperature,  $H_2$  pressure and quantity, refractive index, etc.); and free programmable control circuits, managing a reproducible hydrogenation performance—are available today.

## REFERENCES

1. Patterson, H.B.W., *Hydrogenation of Fats and Oils*, Applied Science Publ., London & New York, 1983.
2. Gemeinschaftsarbeiten der DGF, *Fette Seifen Anstrich*. 78:385 (1976), 79:181, 79:465 (1977), 80:1 (1978).
3. Coenen, J.W.E., *JAACS* 53:382 (1976).
4. Allen, R.R., *JAACS* 55:792 (1978).
5. *Hydrogenation of Oils*, Symposium of ASA Brussels in Rimini, Italy, 1980.
6. Puri, P.S., *JAACS* 57:850 A (1980).
7. Allen, R.R., *JAACS* 58:166 (1981).
8. Hastert, R.C., *JAACS* 58:169 (1981).
9. Hustedt, H.H., *JAACS* 53:390 (1976).
10. Gemeinschaftsarbeiten der DGF, *Fette Seifen Anstrich*. 75:467, 75:587, 75:636 (1973).
11. Albright, L.F., *JAACS* 42:350 (1965).
12. Schmidt, J., *JAACS* 45:520 (1968).
13. Linsen, B.G., *Fette Seifen Anstrich*. 73:411 (1971), II: *JAACS* 73:753 (1971).
14. Scholfield, C.R., R.O. Butterfield, and H.J. Dutton, *JAACS* 56:664 (1979).
15. Allen, R.R., *JAACS* 59:204 (1982); *JAACS* 60:1896 (1983).
16. Beyens, Y., and A.J. Dijkstra, *JAACS*, in press.
17. Houstmuller, U.M.T., *Fette Seifen Anstrich*. 80:162 (1978).
18. Emken, E.A., and H.J. Dutton, *Geometrical and positional fatty acid isomers*, AOCs Monograph No. 6, Champaign, IL 1979.
19. Applewhite, T.H., *JAACS* 58:260 (1981).
20. Perkins, E.G., and W.J. Visek, *Dietary Fats and Health*, AOCs Monograph No. 10, Champaign, IL, 1983.
21. Drozowski, B., and M. Zajac, *JAACS* 54:595 (1977).
22. Klauenberg, G., *The hydrogenation of rapeseed oil*, Internal report of Unichema International.
23. Wehrauch, W., *Verfahrenstechnik* 2:243 (1968).
24. *Ibid.* 6 (1972).
25. Kipke, K., *Verfahrenstechnik* 11:518 (1977).
26. Leuteritz, G., *Chemie, Anlagen und Verfahren Heft 3* (1971).
27. Duveen, R.F., and G. Leuteritz, *Fette Seifen Anstrich*. 84:511 (1982).
28. Lush, J., *Soc. chem. Ind.* 42:219 T (1923); Bolten, J., *Soc. chem. Ind.* 46:444 T (1927).
29. Leuteritz, G., *Fette Seifen Anstrich*. 71:441 (1969).
30. Leuteritz, G.M., *U.S. Patent* 3.823.172 (July 9, 1974).
31. *U.S. Patent* 3.792.067 (1974); DE 2207909 C 2 (Aug. 8, 1983).
32. Duveen, R.F., and R. Steinhauer, *Fette Seifen Anstrich*. im Druck.
33. Bollheimer, P., J. Anglin, and R. Clements, *Hydrogenation plant design and operation*, paper presented at AOCs Annual Meeting, Chicago, May 1983 (Courtesy of Process Systems, Inc., Memphis, TN, U.S.A.).
34. Beckmann, H.J., *JAACS* 60:234 A (1983).
35. Dutton, H.J., S. Koritola and coworkers, *JAACS* 43:86, 43:556 (1966), 44:152 (1967).
36. Baltes, J., *Fette Seifen Anstrich*. 72:425 (1970).
37. Voeste, Th., *Fette Seifen Anstrich*. 75:360 (1973).
38. Skiba, K.J., *Ibid.* 66:1021 (1964).
39. Paulicka, F.R., *JAACS* 53:421 (1976).
40. Marcus, G., and P.S. Puri, *JAACS* 55:610 A (1978).
41. Kheiri, M.S.A., *Formulation and Marketing of Cocoa butter replacer fats*, PORIM occ. paper No. 4, Kuala Lumpur, 1982.
42. Young, F.V.K., *JAACS* 60:326 A (1983).